

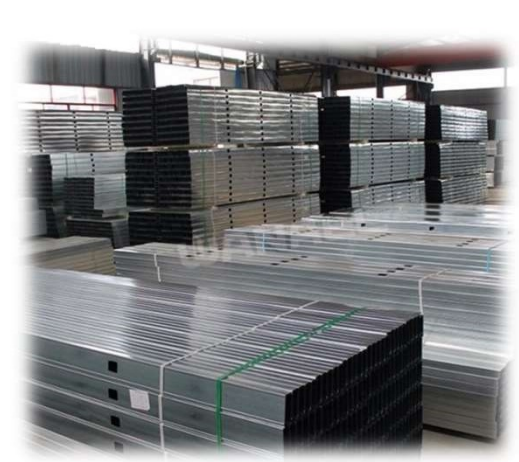

**PROLINE**

**2018**



## ABOUT US ;

Proline Metal, which always aims to grow and continues its investments in the industry with this understanding, has an annual flat product processing volume of 5,000 tons and produces high value added products. Since its establishment; has become one of the leading companies in its sector with its investments, compliance with global quality standards, use of state-of-the-art equipment and rapidly developing structure.

Proline Metal, which sells steel service cold sheet, galvanized sheet, painted sheet and sheet products together with the production processes of Drywall, PVC, Shutter, and Shutter Profiles, is produced in a dynamic organization based on providing the best logistics service to the customer. and foresees the needs of the companies with which it works, and offers appropriate solutions.





Proline Metal , are manufactured from hot dip galvanized steel sheet metals which has zinc coating on both sides. We always supply A class raw materials from Turkish Standards Institute's (TSE) certified plants.

For shipments we request EN 10346 standard. Zinc coating is requested min. 100 gr/m<sup>2</sup> and stored in closed warehouses to protect against sting and oxidation. Every step of production is controlled according to TS EN 14195 standard.



## SUSPENDED CEILING SYSTEMS

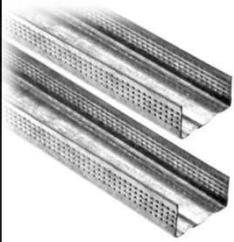

CEILING FORM UD  
Perimeter Profiles

CODE	THICKNESS	SIZE	LENGTH	PACKAGE	PALLET
PRL 001	0,50 - 0,60 mm	24 x 28 x 24	3000 mm	24	49
PRL 002	0,50 - 0,60 mm	24 x 20 x 24	3000 mm	24	49
PRL 003	0,50 - 0,60 mm	24 x 19 x 24	3000 mm	24	49
PRL 004	0,50 - 0,60 mm	24 x 16 x 24	3000 mm	24	49



CEILING FORM CD  
Carrier Profiles

CODE	THICKNESS	SIZE	LENGTH	PACKAGE	PALLET
PRL 005	0,50 - 0,60 mm	27 x 60 x 27	3000 mm	24	49
PRL 006	0,50 - 0,60 mm	19 x 48 x 19	3000 mm	24	49
PRL 006	0,50 - 0,60 mm	15 x 48 x 15	3000 mm	24	49

## SUSPENDED CEILING SYSTEMS



**CURVED PROFILES**  
Can be Bent to All Form

CODE	THICKNESS	SIZE	LENGTH	PACKAGE	PALLET
PRL 007	0,50 mm	24 x 28 x 24	3000 mm	24	49
PRL 008	0,50 mm	35 x 50 x 35	3000 mm	24	49
PRL 009	0,50 mm	35 x 75 x 35	3000 mm	24	49



**CEILING FORM L**  
Perimeter Profiles

CODE	THICKNESS	SIZE	LENGTH	PACKAGE	PALLET
PRL 010	0,50 mm	25 x 25	3000 mm	50	50
PRL 011	0,50 mm	30x 30	3000 mm	50	50

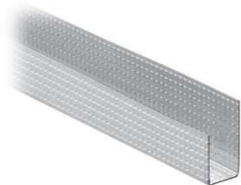

**CEILING FORM J**  
Thin Coat Stop Bead

CODE	THICKNESS	SIZE	LENGTH	PACKAGE	PALLET
PRL 010	0,40 mm	13 x 13 x 25	3000 mm	24	49
PRL 011	0,50 mm	13 x 13 x 25	3000 mm	24	49

## SUSPENDED CEILING SYSTEMS

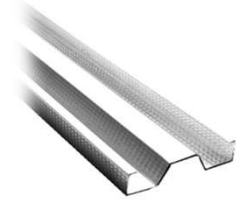

FORM M  
WALL LINING PROFILE

CODE	THICKNESS	SIZE	LENGTH	PACKAGE	PALLET
PRL 012	0,50 - 0,60 mm	28 x 68	2700 mm	12	35
PRL 013	0,50 - 0,60 mm	23 x 23	2700 mm	12	35



OMEGA

CODE	THICKNESS	SIZE	LENGTH	BOX	PALLET
PRL 014	0,50 - 0,60 mm	20 x 68	3000 mm	12	35
PRL 015	0,50 - 0,60 mm	20 x 78	3000 mm	12	35



CANAL U

CODE	THICKNESS	SIZE	LENGTH	BOX	PALLET
PRL 016	0,50 - 0,60 mm	10 x 38 x 10	3000 mm	24	49
PRL 017	0,50 - 0,60 mm	12 x 38 x 10	3000 mm	24	49

## WALL LINING SYSTEM PROFILES



WALL FORM CW  
Stud Profiles

CODE	THICKNESS	SIZE	LENGTH	PACKAGE	PALLET
PRL 018	0,50 - 0,60 mm	35 x 46 x 35	3000 mm	12	49
PRL 019	0,50 - 0,60 mm	35 x 48 x 35	3000 mm	12	49
PRL 020	0,50 - 0,60 mm	35 x 68 x 35	3000 mm	12	35
PRL 021	0,50 - 0,60 mm	40 x 73 x 40	3000 mm	12	35
PRL 022	0,50 - 0,60 mm	35 x 88x 35	3000 mm	12	25
PRL 023	0,50 - 0,60 mm	43 x 98 x 43	3000 mm	12	25



WALL FORM UW  
Track Profiles

CODE	THICKNESS	SIZE	LENGTH	PACKAGE	PALLET
PRL 024	0,50 - 0,60 mm	28 x 48 x 28	3000 mm	12	49
PRL 025	0,50 - 0,60 mm	28 x 50 x 28	3000 mm	12	49
PRL 026	0,50 - 0,60 mm	35 x 70 x 35	3000 mm	12	35
PRL 027	0,50 - 0,60 mm	40 x 75 x 40	3000 mm	12	35
PRL 028	0,50 - 0,60 mm	28 x 90 x 28	3000 mm	12	25
PRL 029	0,50 - 0,60 mm	28 x 90 x 28	3000 mm	12	25

## PLASTERING & DETAIL PROFILES



Plastering  
Corner Bead

CODE	THICKNESS	SIZE	LENGTH	PACKAGE	PALLET
PRL 030	0,30-0,40 mm	20 x 20	2700 mm	50	50
PRL 031	0,30-0,40 mm	23 x 23	2700 mm	50	50
PRL 032	0,30-0,40 mm	27 x 27	2700 mm	50	50



Plastering  
Angle Bead

CODE	THICKNESS	SIZE	LENGTH	BOX	PALLET
PRL 033	0,35-0,50 mm	35 x 35	3000 mm	100	50
PRL 034	0,35-0,50 mm	38 x 38	3000 mm	100	50
PRL 035	0,35-0,50 mm	50 x 50	3000 mm	100	50



Plastering Stop Bead

CODE	THICKNESS	SIZE	LENGTH	BOX	PALLET
PRL 036	0,40-0,50 mm	13 x 13 x 50	3000 mm	50	50
PRL 037	0,40-0,50 mm	13 x 19 x 50	3000 mm	50	50



## PLASTERING & DETAIL PROFILES



Shadow Line  
Perforated - Z Angle

CODE	THICKNESS	SIZE	LENGTH	PACKAGE	PALLET
PRL 038	0,40-0,50 mm	10 x 13 x 28	3000 mm	50	50
PRL 039	0,40-0,50 mm	15 x 13 x 28	3000 mm	50	50
PRL 041	0,40-0,50 mm	20 x 13 x 28	3000 mm	50	50



Plastering  
Angle Bead

CODE	THICKNESS	SIZE	LENGTH	BOX	PALLET
PRL 042	0,35 mm	6 x 20	3000 mm	100	50
PRL 043	0,35 mm	10 x 23	3000 mm	50	50



Plastering  
L Stop Bead

CODE	THICKNESS	SIZE	LENGTH	PACKAGE	PALLET
PRL 044	0,30 mm	12 x 28	3000 mm	50	50
PRL 045	0,40 mm	12 x 28	3000 mm	50	50

## PLASTIC PROFILES



Plastic Plastering  
Corner Bead

CODE	THICKNESS	SIZE	LENGTH	BOX	PALLET
PRL 046	0,50 mm	20 x 20	2500 mm	100	50
PRL 047	0,50 mm	23 x 23	2500 mm	100	50



Plastic Curved Profile

CODE	THICKNESS	SIZE	LENGTH	BOX	PALLET
PRL 048	0,50 mm	23 x 30	2500 mm	100	50
PRL 049	0,50 mm	23 x 30	3000 mm	100	50



Plastic Dry Wall  
Meshed Corner

CODE	THICKNESS	SIZE	LENGTH	BOX	PALLET
PRL 050	0,50 mm	40 x 40	2500 mm	100	50
PRL 051	0,50 mm	50 x 50	2500 mm	100	50

## PROFILE ACCESSORIES

PRODUCT

SIZE

PALLET



### PRL 052 - BRACKET

it is can be bent by hand.  
Assembly material.Lengths will be adjusted according to demand.

Thickness :0,70 - 0,80 mm  
100 Pieces /Package

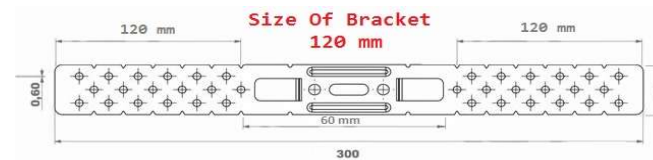

100 Pieces /Package  
100 Package / Pallet

PRODUCT

SIZE

PALLET

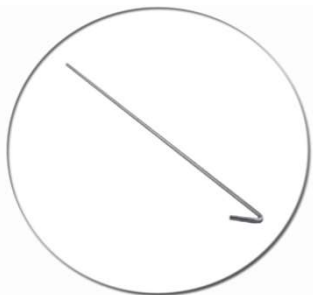

### PRL 053 - HANGER STICK

Length will be determined according to demand.  
100 Pieces /Package

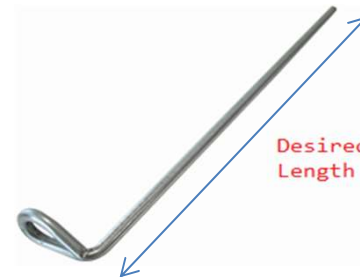

100 Pieces /Package  
100 Package / Pallet

## PROFILE ACCESSORIES

### PRODUCT AND PACKING

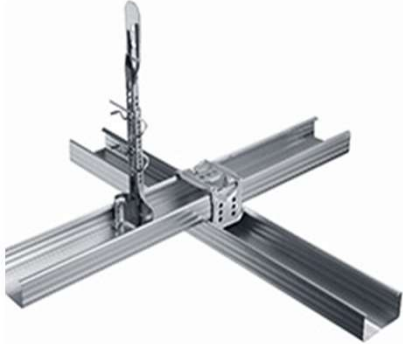

HANGER PLATE

**PRL 054**

500 Pcs / Box  
25 Box / Pallet



CLIPS

**PRL 055**

1000 Pcs / Box  
25 Box / Pallet

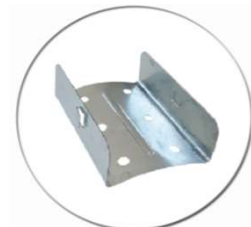

CONNECTOR

**PRL 056**

500 Pcs / Box  
25 Box / Pallet



**PRL 057**

1000 Pcs / Box  
25 Box / Pallet



ANCHOR SLIDE

**PRL 058**

1000 Pcs / Box  
25 Box / Pallet



JOINT TAPE

**PRL 059**

12 Pcs / Box  
25 Box / Pallet



**PRL 060**



10 Pcs / Box  
25 Box / Pallet



PLASTERBOARD

150 Kg / m<sup>3</sup>  
150 Kg / m<sup>3</sup>  
60 x 120 cm

## PROFILE ACCESSORIES

	PRODUCT	PACKAGE	PALLET
 <p>PLASTIC ANCHOR AND SCREW 45 x 50</p>	2.5 x 35 mm POINTED SCREWS	12000 pcs / box	20 Box / Pallet
	3.5 x 35 mm POINTED SCREWS	10000 pcs / box	20 Box / Pallet
	4.5 x 35 mm POINTED SCREWS	10000 pcs / box	20 Box / Pallet
 <p>STEEL ANCHOR</p>	2.5 x 35 mm DRILLING SCREWS	12000 pcs / box	20 Box / Pallet
	3.5 x 35 mm DRILLING SCREWS	10000 pcs / box	20 Box / Pallet
	4.5 x 50 WOOD SCREWS	5000 pcs / box	20 Box / Pallet
 <p>ALL SCREWS</p>	5.0 x 50 WOOD SCREWS	5000 pcs / box	20 Box / Pallet
	7.5 x 80 BULDEX SCREWS	3000 pcs / box	20 Box / Pallet
	7.5 x 100 BULDEX SCREWS	3000 pcs / box	20 Box / Pallet
	7.5 x 120 BULDEX SCREWS	3000 pcs / box	20 Box / Pallet
	STEEL ANCHOR	1000 pcs / box	20 Box / Pallet
	PLASTIC ANCHOR	1000 pcs / Package	30 Packages / Sack



## ANALYZE OF PLASTERBOARD SUSPENDED CEILING

(Quantities might change according to different projects. No wastage is considered.)

PRODUCT INFORMATION	USAGE	1 mt <sup>2</sup>
PLASTERBOARD	1	mt <sup>2</sup>
CEILING FORM U PROFILE	1	meter
CEILING FORM C PROFILE	2,5	meter
HANGER PLATE	1	piece
CLIPS	5	piece
CONNECTOR	0,5	piece
45 x 50 WOOD SCREWS	2,5	piece
PLASTIC ANCHOR	2,5	piece
STEEL ANCHOR	1	piece
HANGER STICK ( Length will be determined according to demand )	1	piece
SELF TAPING SCREWS Black ,Coarse Thread, Bugle Head 25x35 mm	20	piece
JOINT TAPE 90 meter	0,8	meter
JOINT PLASTER	0,6	kg
SOLATION MATERIALS (Product type will determine according to demand.)	1	mt <sup>2</sup>

\* Quantities might change according to different projects.

No wastage is considered.

## ANALYZE OF PLASTERBOARD SUSPENDED CEILING

(Quantities might change according to different projects. No wastage is considered.)

We have collected all the necessary items for the application of 100 m<sup>2</sup> drywall in a box. This will provide you the benefit of controlling items spared in construction sites.

- \* 500 Pieces of clips
- \* 250 Pieces of anchor - 45 x50 screw
- \* 100 Pieces of steel anchor
- \* 2000 Pieces 2,5 x 35 Pointed Screws
- \* 100 Pieces of hanger plate
- \* 50 Pieces of extension piece

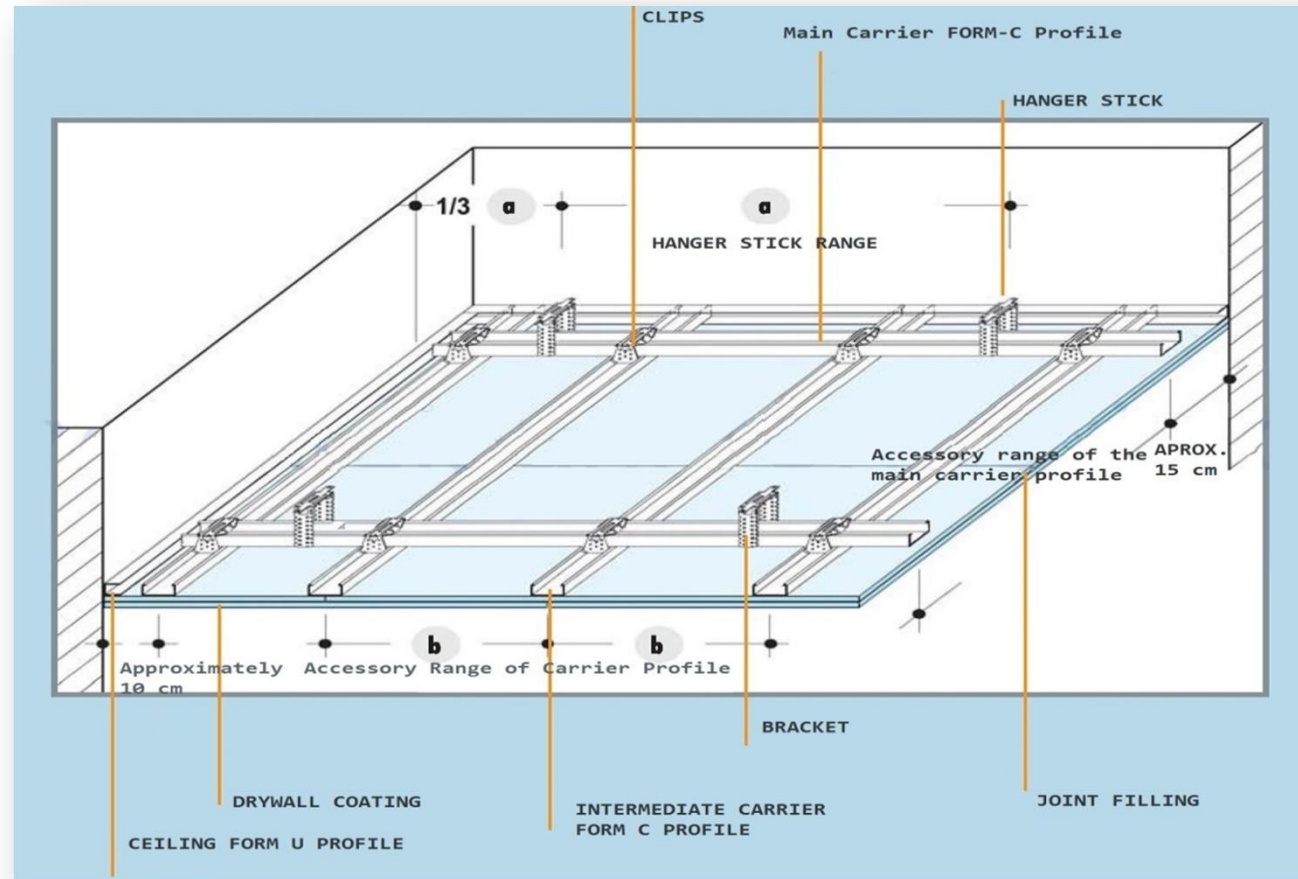

## PLASTERBOARD ONE SIDE - BRACKET WALL ASSEMBLY ANALYSE

( Quantites might change according to different projects. No wastage is considered)

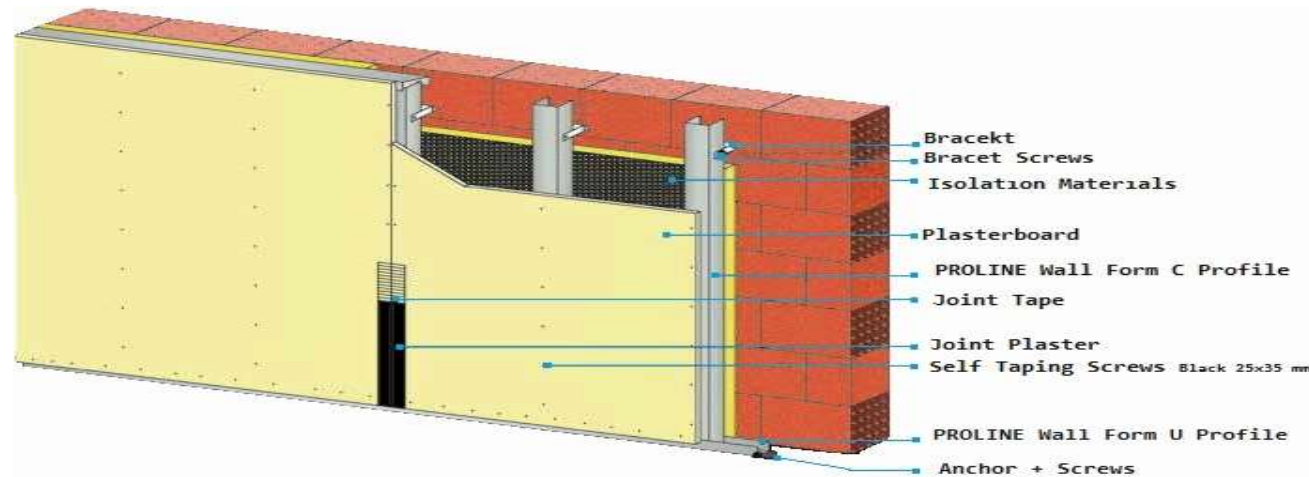

PRODUCT INFORMATION	USAGE	1 mt <sup>2</sup>
PLASTERBOARD	1,00	mt <sup>2</sup>
PROLINE CEILING FORM U PROFILE	1,00	meter
PROLINE CEILING FORM C PROFILE	2,70	meter
HANGER PLATE	1,00	piece
CLIPS	5,00	piece
CONNECTOR	0,50	piece
45 x 50 WOOD SCREWS	2,50	piece
PLASTIC ANCHOR	2,50	piece
STEEL ANCHOR	1,00	piece
HANGER STICK ( Length will be determined according to demand )	1,00	piece
SELF TAPING SCREWS Black ,Coarse Thread, Bugle Head 25x35 mm	20,00	piece
JOINT TAPE 90 meter	0,80	meter
JOINT PLASTER Izocam	0,60	kg
SOLATION MATERIALS (Product type will determine according to demand.)	1,00	mt <sup>2</sup>



## PLASTERBOARD DOUBLE SIDE SEPERATION WALL ANALYSE

(Quantities might change according to different projects. No wastage is considered)

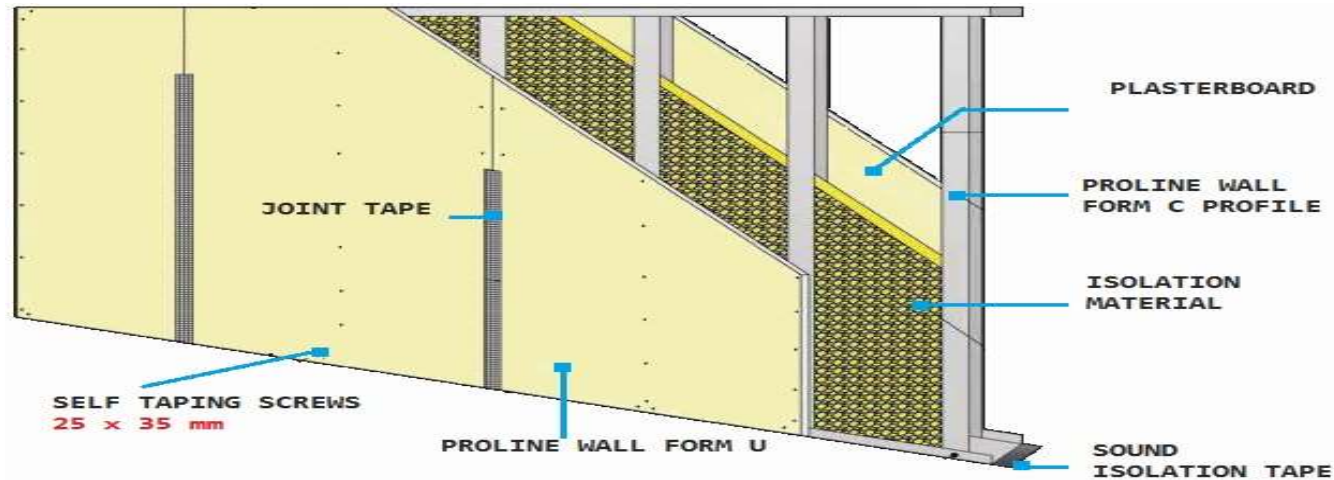

PRODUCT INFORMATION	USAGE	1 mt <sup>2</sup>
PLASTERBOARD	2,00	mt <sup>2</sup>
PROLINE WALL FORM U PROFILES ( 50 - 75 -100 )	1,00	meter
PROLINE WALL FORM C PROFILE ( 50 - 75 -100 )	2,30	meter
SELF TAPING SCREWS Black ,Coarse Thread, Bugle Head 25x35 mm	30,00	piece
ISOLTION MATERIAL (Izocam - Product type will determine according to demand )	5,00	piece
SOUND ISOLTION TAPE ( Width should be same with U profile )	0,50	piece
45 x 50 WOOD SCREWS	2,50	piece
PLASTIC ANCHOR	2,50	piece
JOINT TAPE 90 meter	1,60	piece
JOINT PLASTER	1,20	piece

2019



# PROLINE

## ALÇIPAN PROFİLLERİ

Metal Ürünleri Ve Mak.San.Tic.Ltd.Sti.

CREATED USING  
**POWTOON**

PROLINE METAL ÜRÜNLERİ VE MAK.SAN.TİC.LTD ŞTİ  
ADRESS : GÜLENSU MH.GAZI SOK.NO:24/A MALTEPE İSTANBUL ,  
TURKEY  
TELEPHONE : +90 216 589 9203  
WHATSAPP / MOBILE : +90 545 533 4489  
E-MAIL : [info@prolineprofil.com](mailto:info@prolineprofil.com)  
WEB : [www.prolineprofil.com.tr](http://www.prolineprofil.com.tr)